



we think transport

SIMAC[®] SOLUTIONS

Control of flashing side marker lights

 **CERMAX[®]**

The Ermax solution is called SIMAC®

Compliant to legislation with unique flexibility

Control of flashing side marker lights ECE 48 since November 2017

With the ECE regulation No. 48 (Changes series 06) it is prescribed that the side marker lights must flash synchronously and simultaneously with the direction indicators (in the tail light) – this is mandatory for vehicles – class 03 and 04 - being homologated after November 18 2017.

Ermax SIMAC® ensures the compliance with the legislation
– we will advise the optimal application

SIMAC: Side marker lights Control

SIMAC "Snap-In" module

- Ideal for any application, even in retrofit
- The flexible solution in order to keep an existing kit configuration almost unchanged

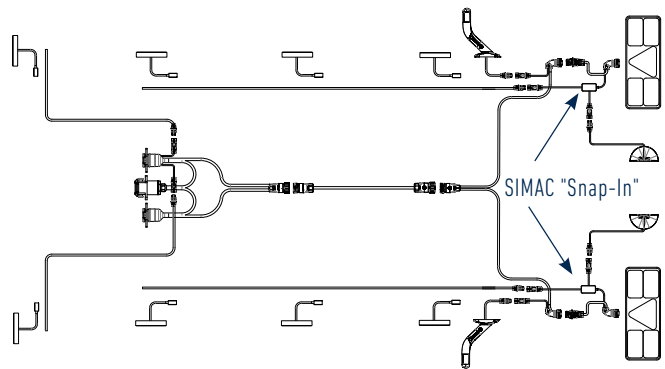

SIMAC integrated in the junction box

- Mounted in a secure and protected position with ideal plug connection to the system
- The best possible solution especially when 3 & 2 function lights are being used

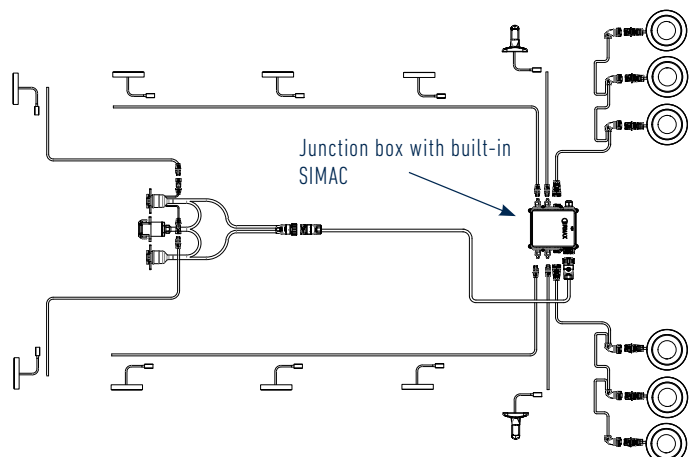

ERMAX side marker lights



- Standard mounting
- 2 LED diodes
- 4 mounting versions
- 4 cable versions
- IP69K rating



- Mounting without visible screws
- 2 LED diodes
- 4 mounting versions
- 3 cable versions
- IP69K rating

SIMAC integrated in the rear cable

- Optimised design for easy mounting
- Ideal for the lean high-volume solution

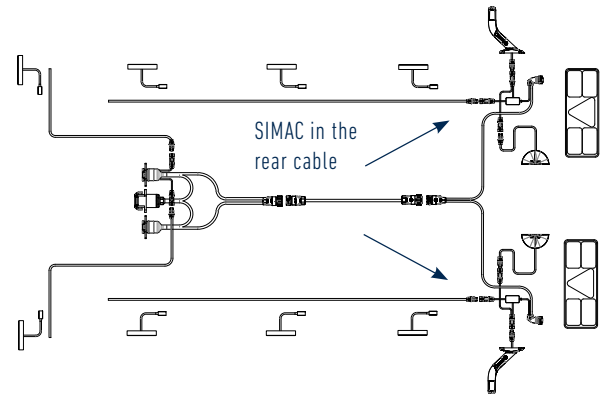
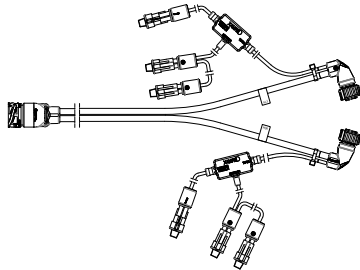

SIMAC as adapter in the main cable

- Allows mounting of side cables from front to back
- Recommendable when a LED control box is used in the cable system

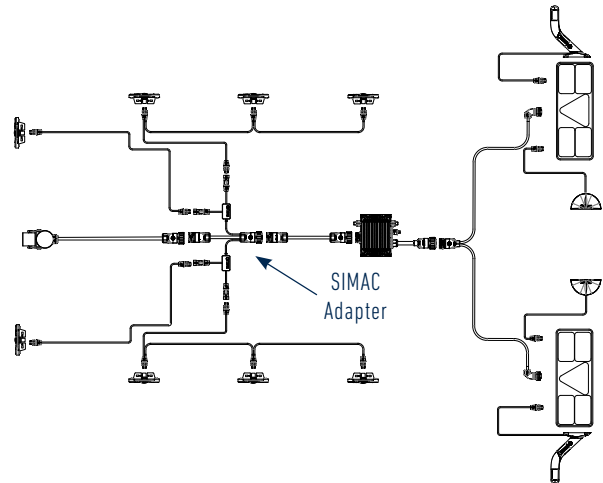
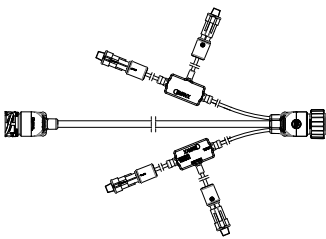

SIMAC integrated in the tail light

- The easy and ideal solution without external modules
- No further parts or components needed



TM10 LED



TM11 LED

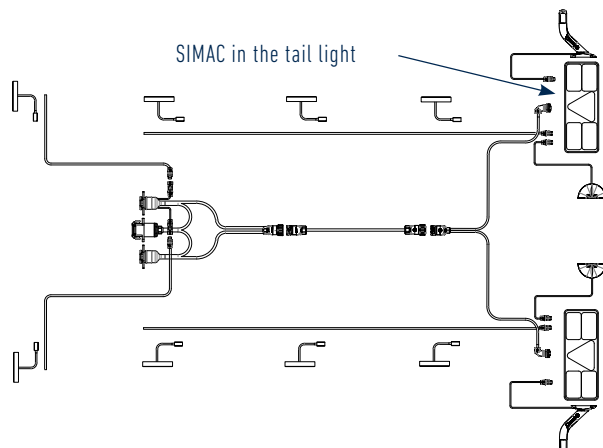

Die Marken der BPW Gruppe:



September 2018 • Version 1.0



ERMAX A/S
Vranderupvej 2 • DK-6000 Kolding
Tel. +45 3969 6800 • www.ermax.dk